

# Protection Devices

TVS (Transient Voltage Suppressor)

## ESD102-U1-02ELS

Uni-directional, 3.3 V, 0.4 pF, 0201, RoHS

ESD102-U1-02ELS

## Data Sheet

Revision 1.2, 2015-12-14  
Final

Power Management & Multimarket

**Edition 2015-12-14**

**Published by**

**Infineon Technologies AG**

**81726 Munich, Germany**

**© 2015 Infineon Technologies AG**

**All Rights Reserved.**

### **Information**

For further information on technology, delivery terms and conditions and prices, please contact the nearest Infineon Technologies Office ([www.infineon.com](http://www.infineon.com))

### **Warnings**

Due to technical requirements, components may contain dangerous substances. For information on the types in question, please contact the nearest Infineon Technologies Office.

Infineon Technologies components may be used in life-support devices or systems only with the express written approval of Infineon Technologies, if a failure of such components can reasonably be expected to cause the failure of that life-support device or system or to affect the safety or effectiveness of that device or system. Life support devices or systems are intended to be implanted in the human body or to support and/or maintain and sustain and/or protect human life. If they fail, it is reasonable to assume that the health of the user or other persons may be endangered.

# 1 Product Overview

## 1.1 Features

- ESD / transient protection of high speed data lines according to:
  - IEC61000-4-2 (ESD):  $\pm 20$  kV (air / contact)
  - IEC61000-4-4 (EFT):  $\pm 2.5$  kV / 50 A (5/50 ns)
  - IEC61000-4-5 (surge):  $\pm 3$  A (8/20  $\mu$ s)
- Uni-directional working voltage:  $V_{RWM} = 3.3$  V
- Ultra low capacitance:  $C_L = 0.4$  pF (typical)
- Very low clamping voltage:  $V_{CL} = 8$  V (typical) at  $I_{PP} = 16$  A
- Low reverse current:  $I_R = 1$  nA (typical)
- Very low dynamic resistance:  $R_{DYN} = 0.19$   $\Omega$  (typical)
- Pb-free (RoHS compliant) and halogen free package, very small form factor 0.62 x 0.32 x 0.31 mm<sup>3</sup>



## 1.2 Application Examples

- USB 3.0, 10/100/1000 Ethernet, Firewire, DVI, HDMI, S-ATA, DisplayPort
- Mobile HDMI Link, MDDI, MIPI, SWP / NFC

## 1.3 Product Description

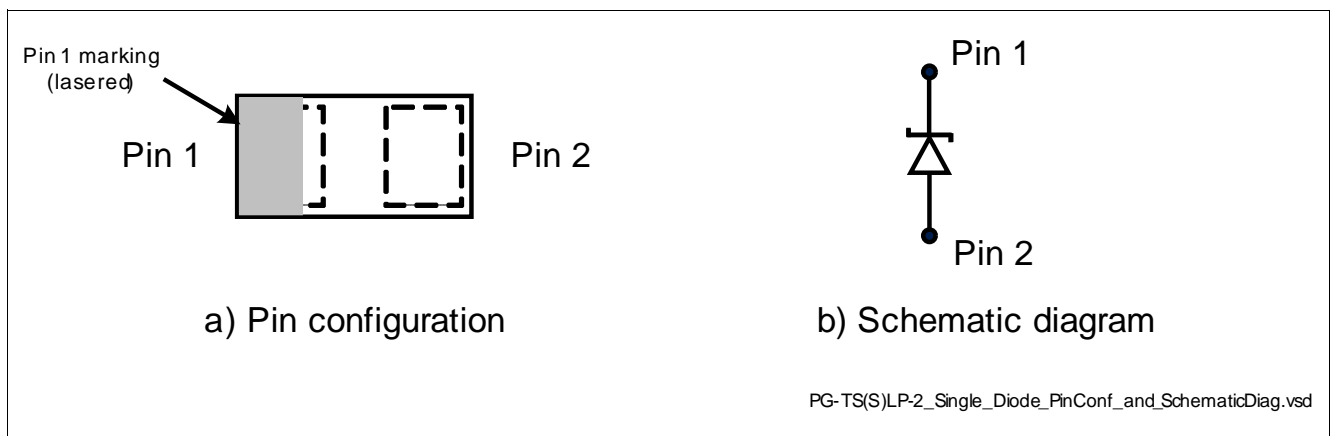

Figure 1 Pin Configuration and Schematic Diagram

Table 1 Part Information

Type	Package	Configuration	Marking code
ESD102-U1-02ELS	TSSLP-2-3	1 line, uni-directional	<u>E</u>

## 2 Maximum Ratings

**Table 2** Maximum Rating at  $T_A = 25\text{ }^\circ\text{C}$ , unless otherwise specified

Parameter	Symbol	Values	Unit
ESD air discharge <sup>1)</sup>	$V_{ESD}$	$\pm 20$	kV
ESD contact discharge <sup>1)</sup>		$\pm 20$	
Peak pulse current <sup>2)</sup>	$I_{PP}$	$\pm 3$	A
Operating temperature	$T_{OP}$	-55 to 125	$^\circ\text{C}$
Storage temperature	$T_{stg}$	-65 to 150	$^\circ\text{C}$

1)  $V_{ESD}$  according to IEC61000-4-2

2) Stress pulse: 8/20 $\mu\text{s}$  current waveform according to IEC61000-4-5

**Attention:** Stresses above the max. values listed here may cause permanent damage to the device. Exposure to absolute maximum rating conditions for extended periods may affect device reliability. Maximum ratings are absolute ratings; exceeding only one of these values may cause irreversible damage to the integrated circuit.

## 3 Electrical Characteristics at $T_A = 25\text{ }^\circ\text{C}$ , unless otherwise specified

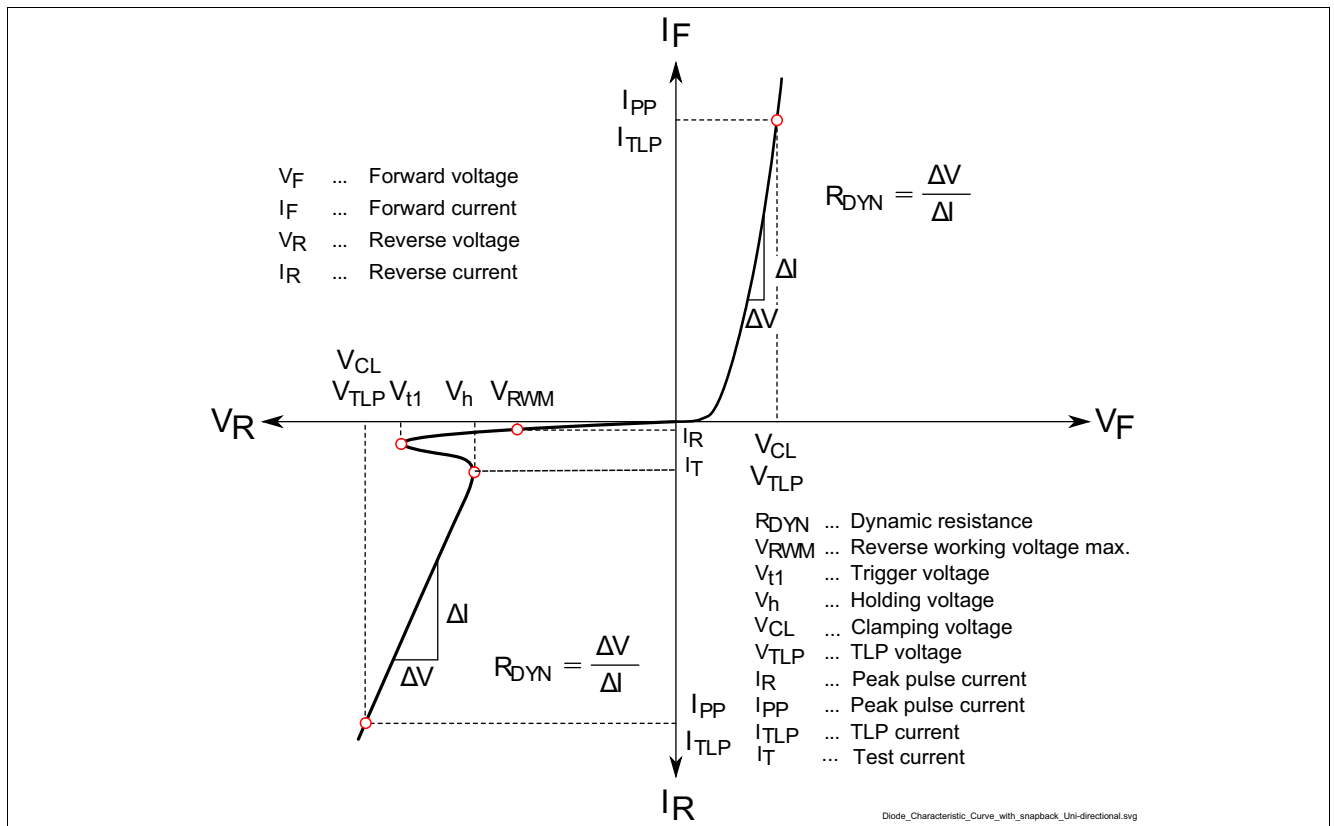

**Figure 2** Definitions of Electrical Characteristics

**Electrical Characteristics at  $T_A = 25\text{ }^\circ\text{C}$ , unless otherwise specified**
**Table 3 DC Characteristics at  $T_A = 25\text{ }^\circ\text{C}$ , unless otherwise specified**

Parameter	Symbol	Values			Unit	Note / Test Condition
		Min.	Typ.	Max.		
Reverse working voltage	$V_{RWM}$	–	–	3.3	V	Pin 1 to Pin 2
Trigger voltage	$V_{t1}$	–	6.2	–		
Holding voltage	$V_h$	3.35	4	4.4		Pin 1 to Pin 2, $I_R = 10\text{ mA}$
Reverse current	$I_R$	–	1	50	nA	$V_R = 3.3\text{ V}$ , from Pin 1 to Pin 2

**Table 4 AC Characteristics at  $T_A = 25\text{ }^\circ\text{C}$ , unless otherwise specified**

Parameter	Symbol	Values			Unit	Note / Test Condition
		Min.	Typ.	Max.		
Line capacitance	$C_L$	–	0.4	0.65	pF	$V_R = 0\text{ V}$ , $f = 1\text{ MHz}$
		–	0.4	0.65	pF	$V_R = 0\text{ V}$ , $f = 1\text{ GHz}$
Series inductance	$L_S$	–	0.2	–	nH	

**Table 5 ESD and Surge Characteristics at  $T_A = 25\text{ }^\circ\text{C}$ , unless otherwise specified**

Parameter	Symbol	Values			Unit	Note / Test Condition
		Min.	Typ.	Max.		
Clamping voltage <sup>1)</sup>	$V_{CL}$	–	8	–	V	$I_{TLP} = 16\text{ A}$ , $t_p = 100\text{ ns}$ , from Pin 1 to Pin 2
		–	11	–		$I_{TLP} = 30\text{ A}$ , $t_p = 100\text{ ns}$ from Pin 1 to Pin 2
Forward clamping voltage <sup>1)</sup>	$V_{FC}$	–	6	–		$I_{TLP} = 16\text{ A}$ , $t_p = 100\text{ ns}$ , from Pin 2 to Pin 1
		–	9	–		$I_{TLP} = 30\text{ A}$ , $t_p = 100\text{ ns}$ , from Pin 2 to Pin 1
Dynamic resistance <sup>1)</sup>	$R_{DYN}$	–	0.19	–	$\Omega$	$t_p = 100\text{ ns}$ from Pin 1 to Pin 2
		–	0.23	–	$\Omega$	$t_p = 100\text{ ns}$ from Pin 2 to Pin 1

1) Please refer to Application Note AN210[1]. TLP parameter:  $Z_0 = 50\text{ }\Omega$ ,  $t_p = 100\text{ ns}$ ,  $t_r = 0.6\text{ ns}$ .

Typical Characteristics at  $T_A=25^\circ\text{C}$ , unless otherwise specified

#### 4 Typical Characteristics at $T_A=25^\circ\text{C}$ , unless otherwise specified

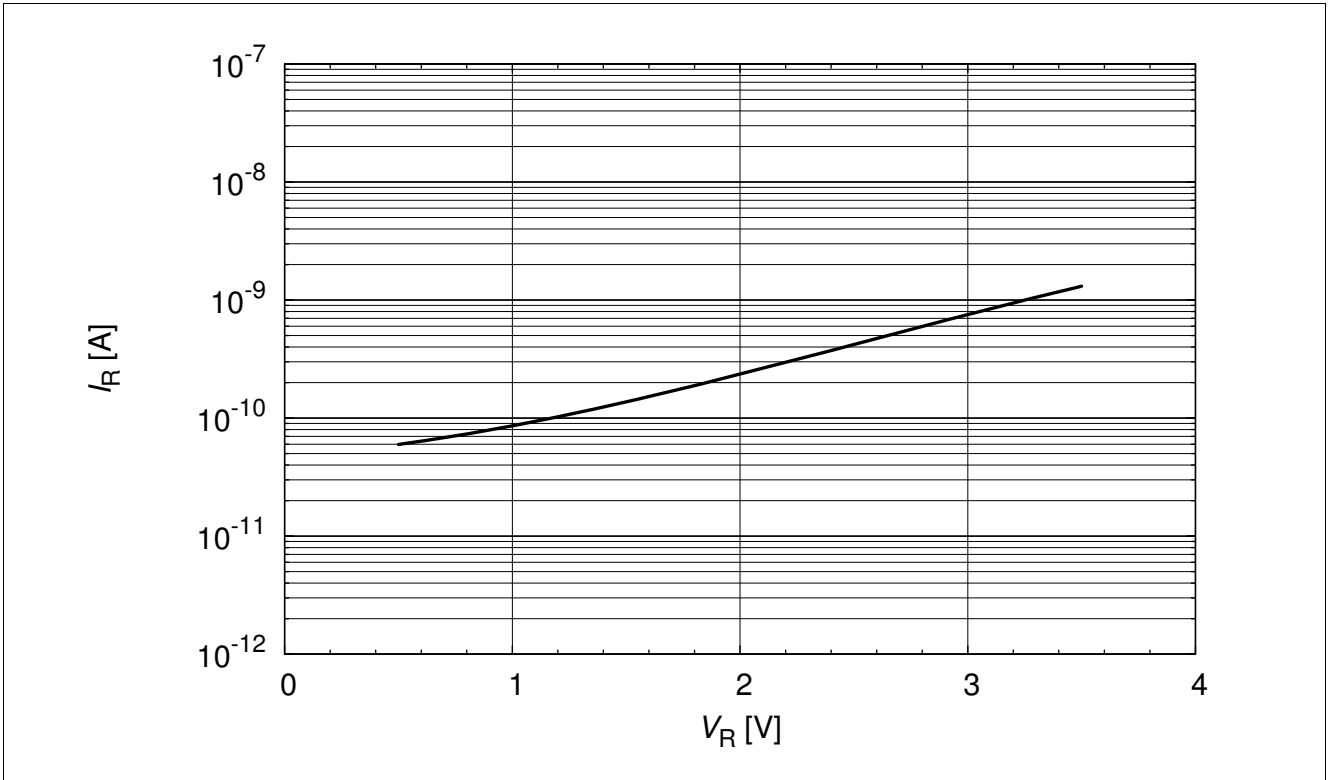

Figure 3 Reverse leakage current,  $I_R = f(V_R)$

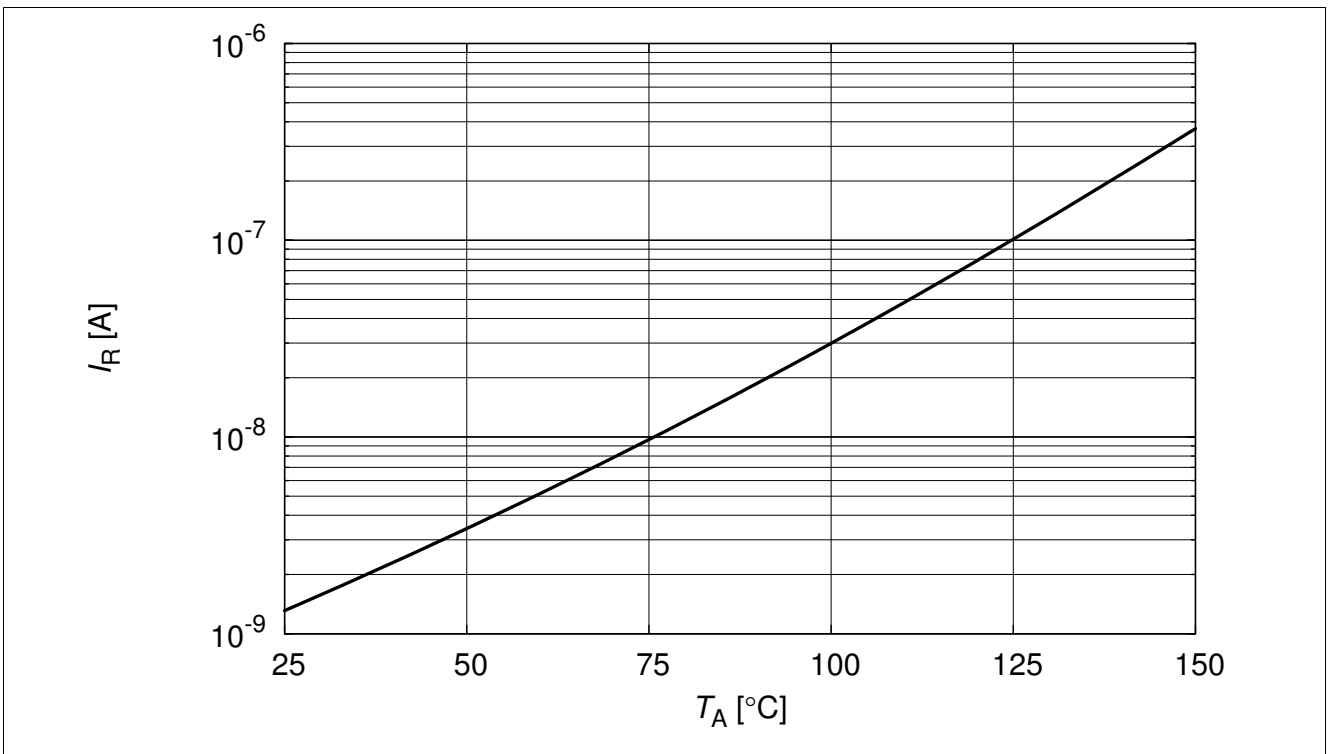

Figure 4 Reverse current  $I_R = f(T_A)$ ,  $V_R = 3.3 \text{ V}$

Typical Characteristics at  $T_A=25^\circ\text{C}$ , unless otherwise specified

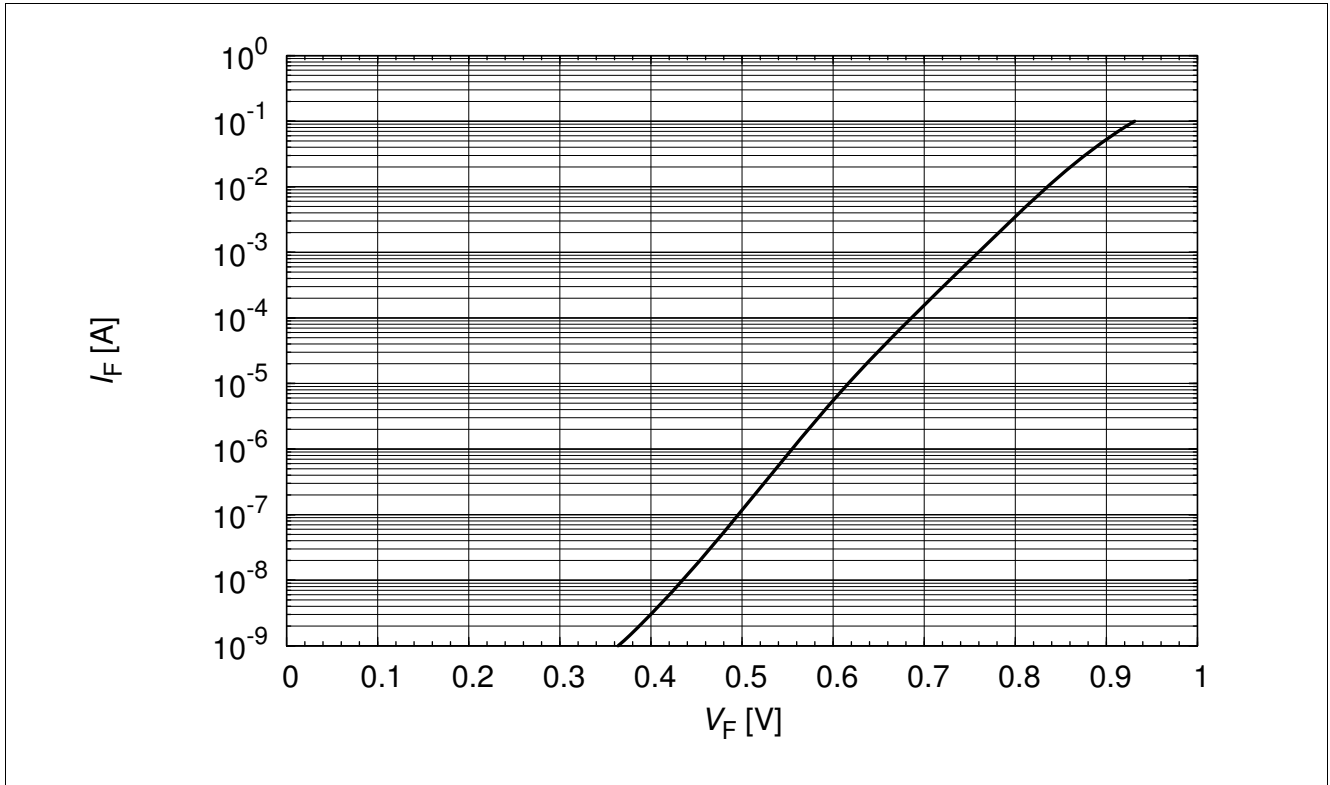

Figure 5 Forward current,  $I_F = (V_F)$

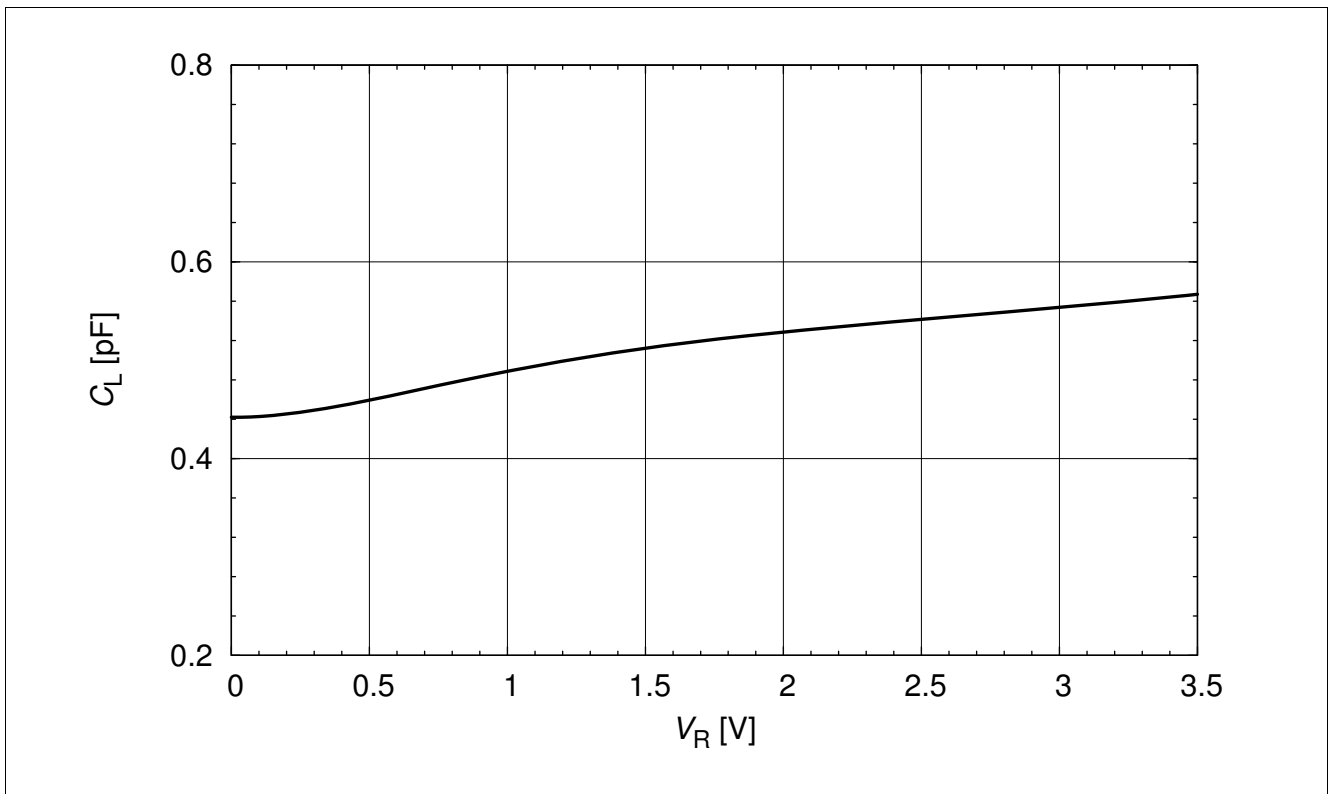

Figure 6 Line capacitance  $C_L = f(V_R), f = 1\text{MHz}$ , from pin 1 to pin 2

Typical Characteristics at  $T_A=25^{\circ}\text{C}$ , unless otherwise specified

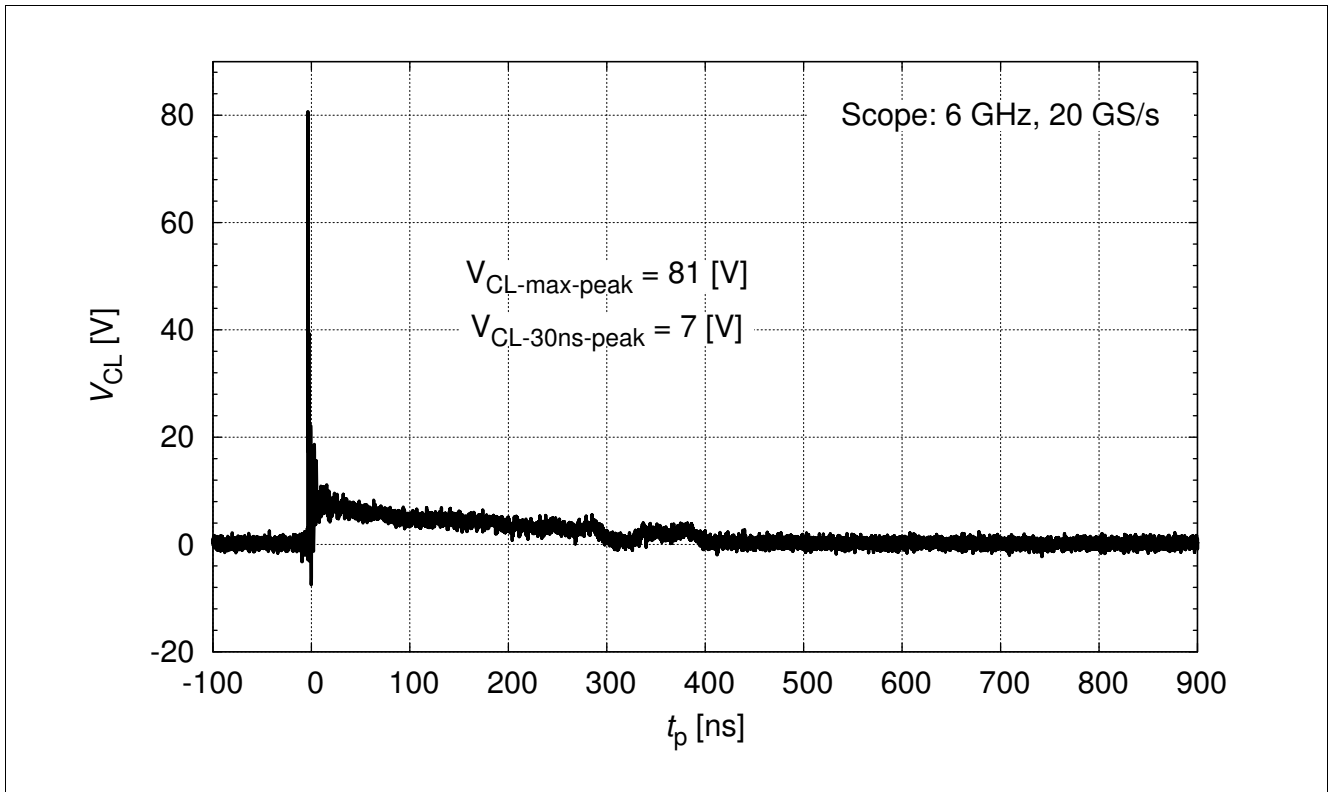

Figure 7 Clamping voltage (ESD):  $V_{\text{CL}} = f(t)$ , 8 kV positive pulse from pin 1 to pin 2

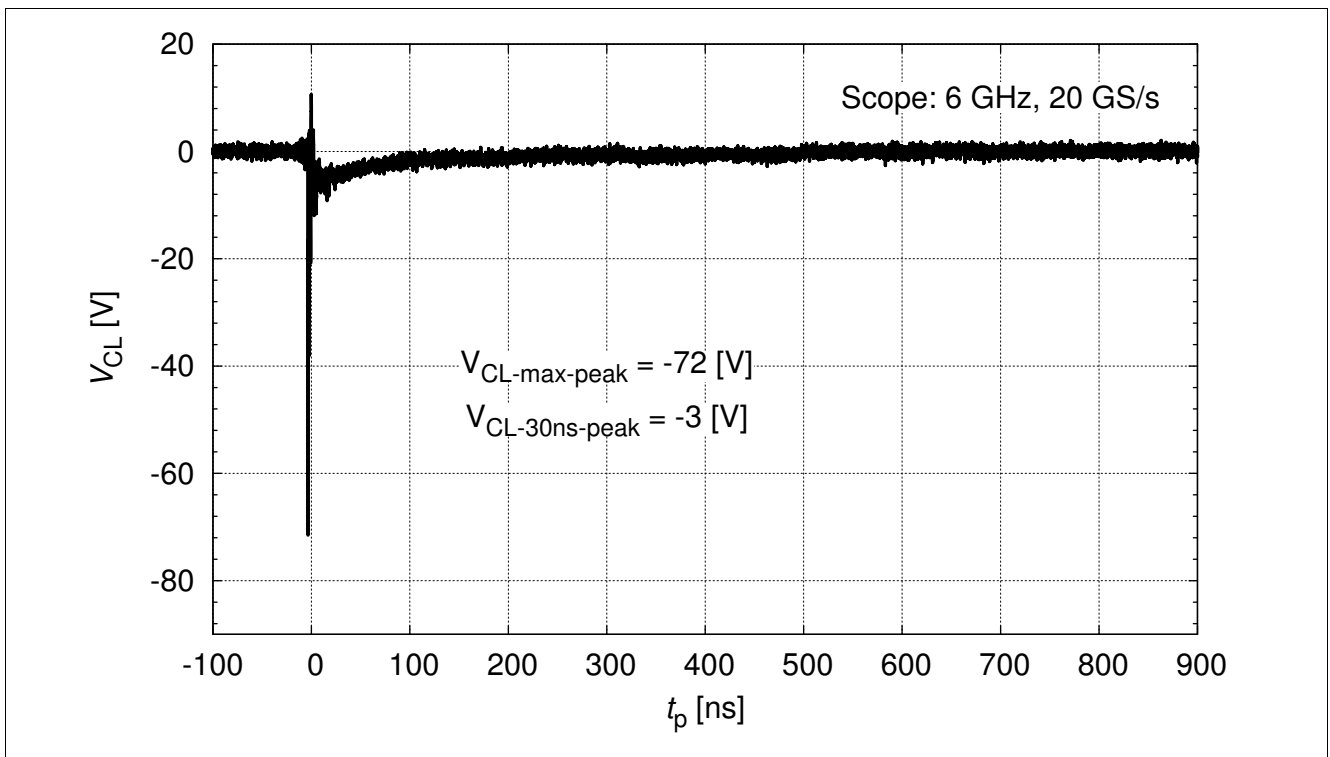

Figure 8 Clamping voltage (ESD):  $V_{\text{CL}} = f(t)$ , 8 kV negative pulse from pin 1 to pin 2



Typical Characteristics at  $T_A=25^\circ\text{C}$ , unless otherwise specified

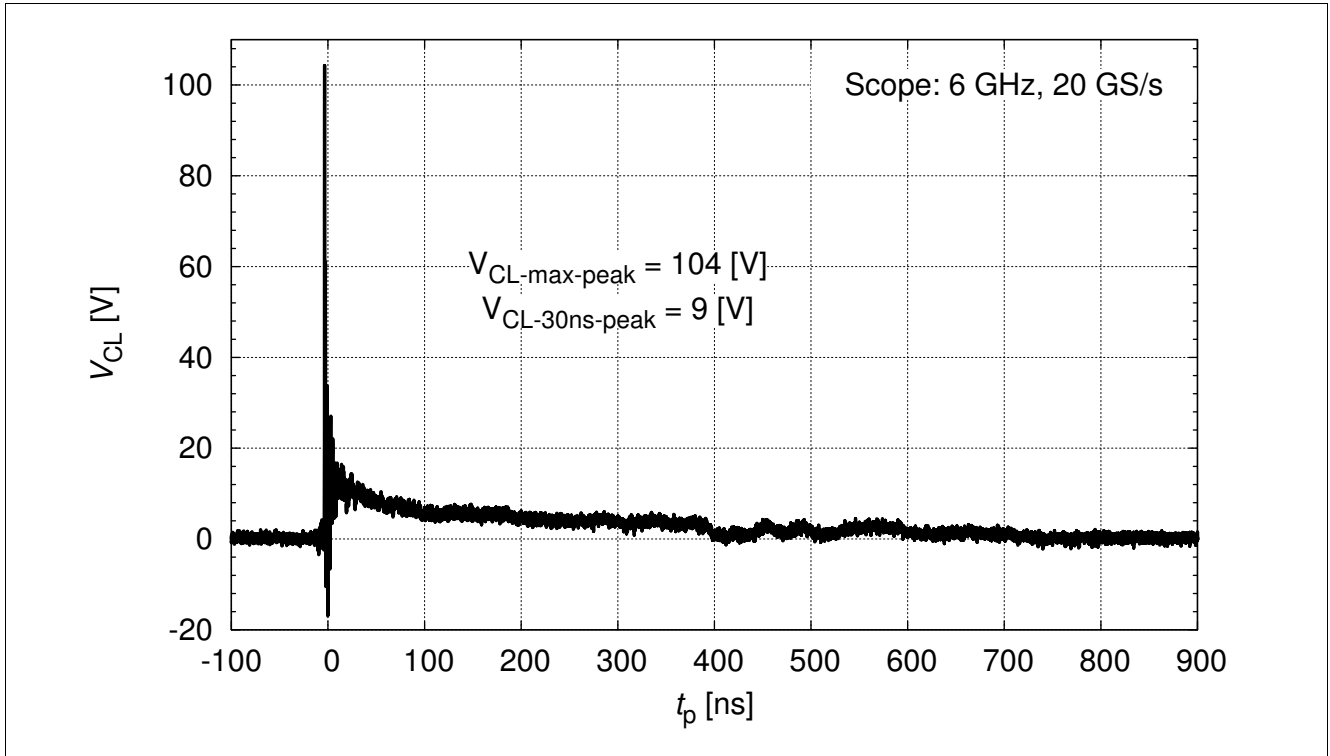

Figure 9 Clamping voltage (ESD):  $V_{CL} = f(t)$ , 15 kV positive pulse from pin 1 to pin 2

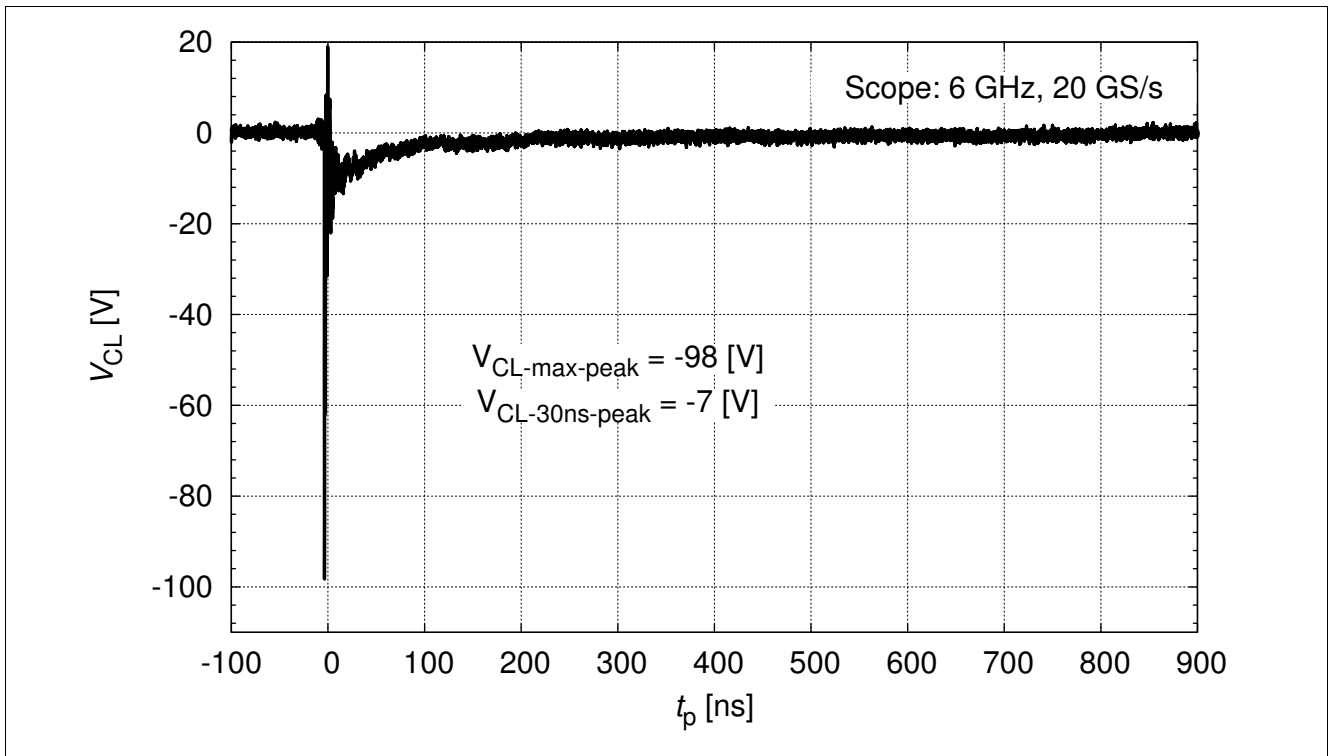

Figure 10 Clamping voltage (ESD):  $V_{CL} = f(t)$ , 15 kV negative pulse from pin 1 to pin 2

Typical Characteristics at  $T_A=25^\circ\text{C}$ , unless otherwise specified

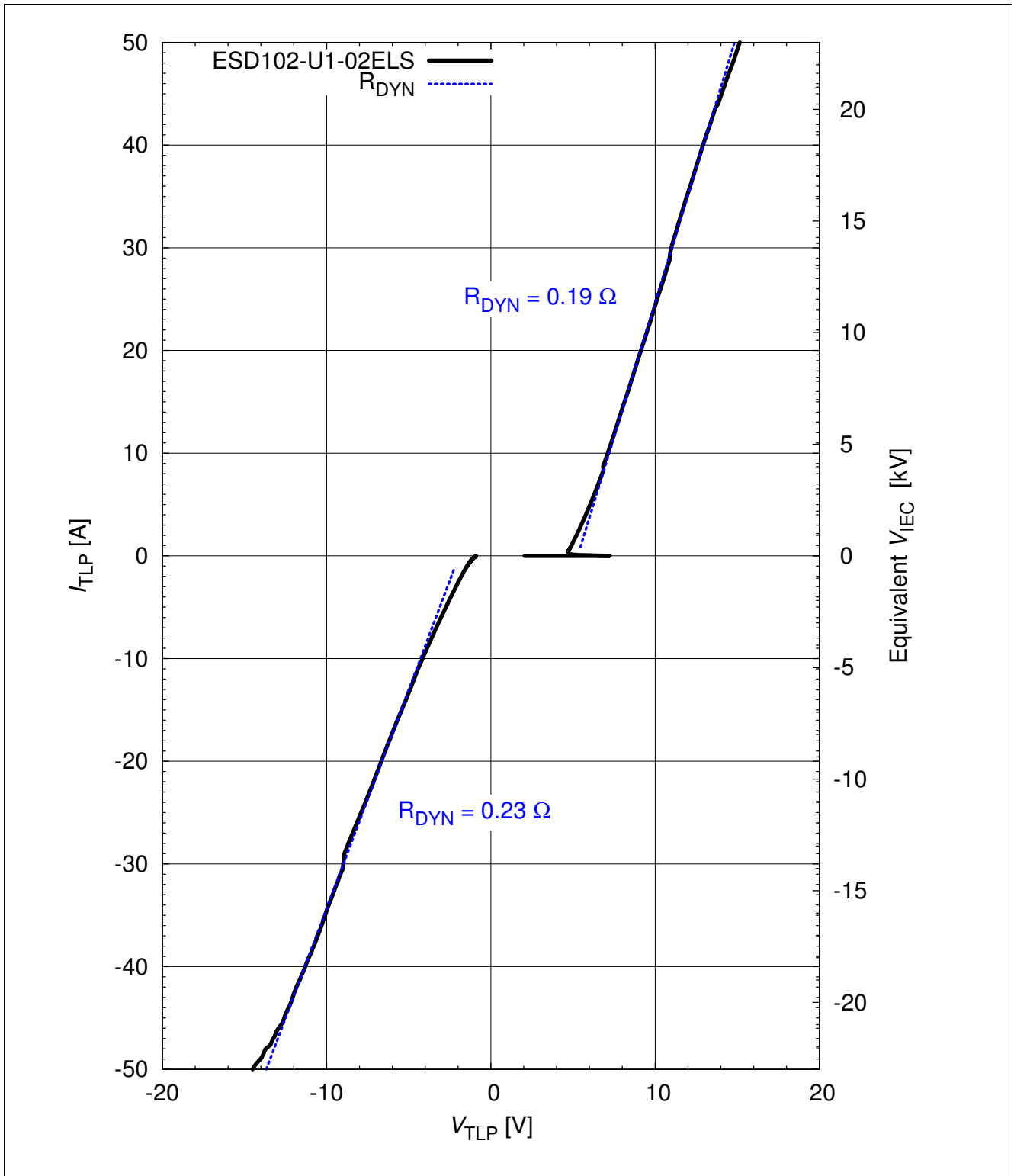

Figure 11 Clamping voltage (TLP):  $I_{TLP} = f(V_{TLP})$  [1], pin 1 to pin 2

Typical Characteristics at  $T_A=25^\circ\text{C}$ , unless otherwise specified

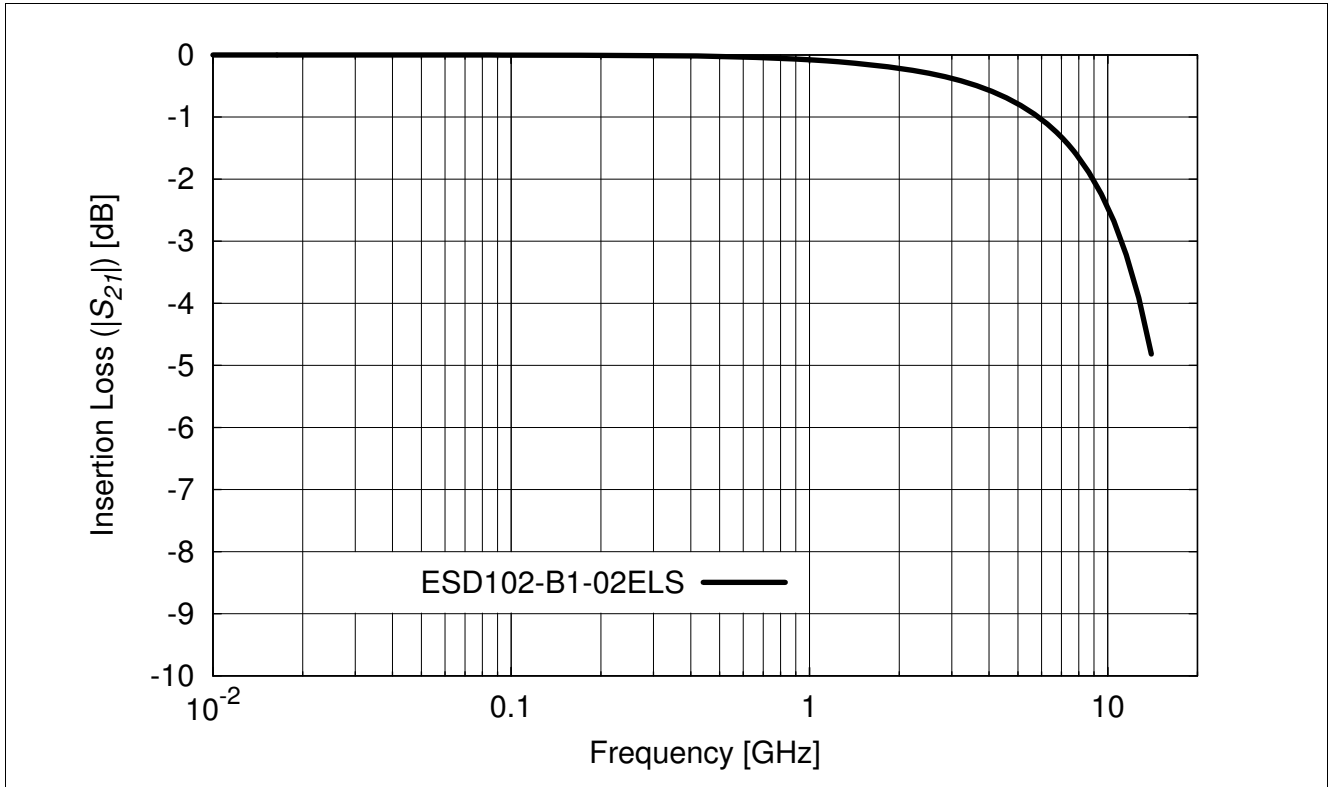

Figure 12 Insertion loss vs. frequency in a 50 Ω system

## 5 Application Information

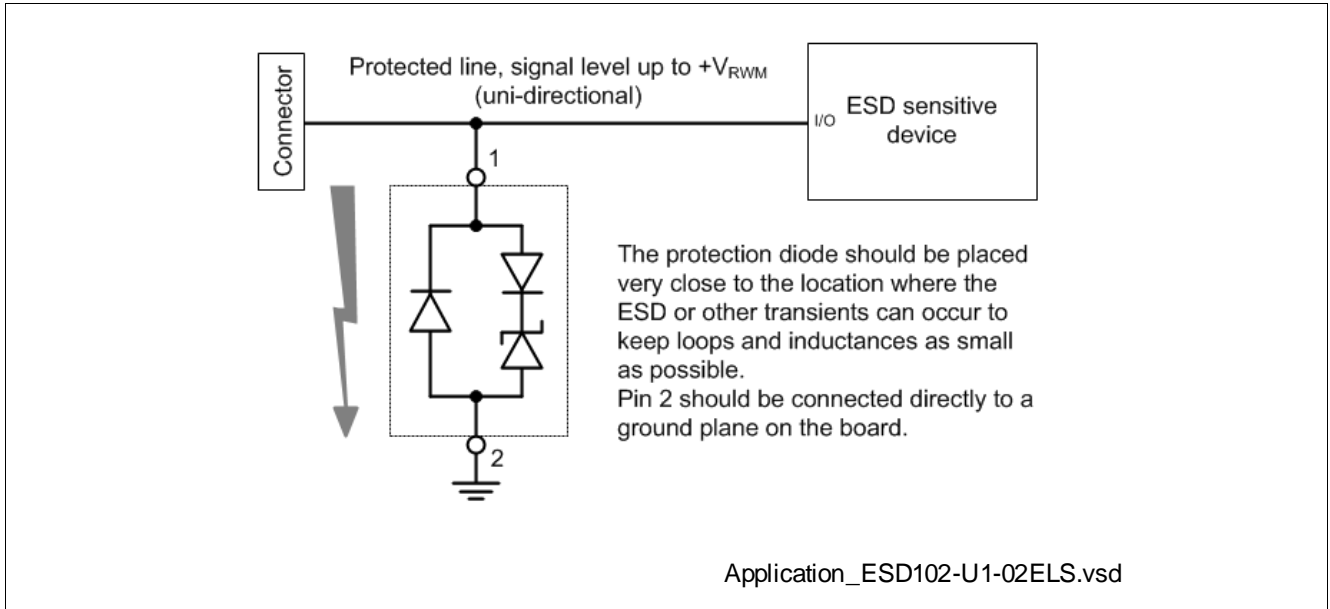

Figure 13 Single line, uni-directional ESD / Transient protection[2]

## 6 Package Information

### 6.1 TSSLP-2-3

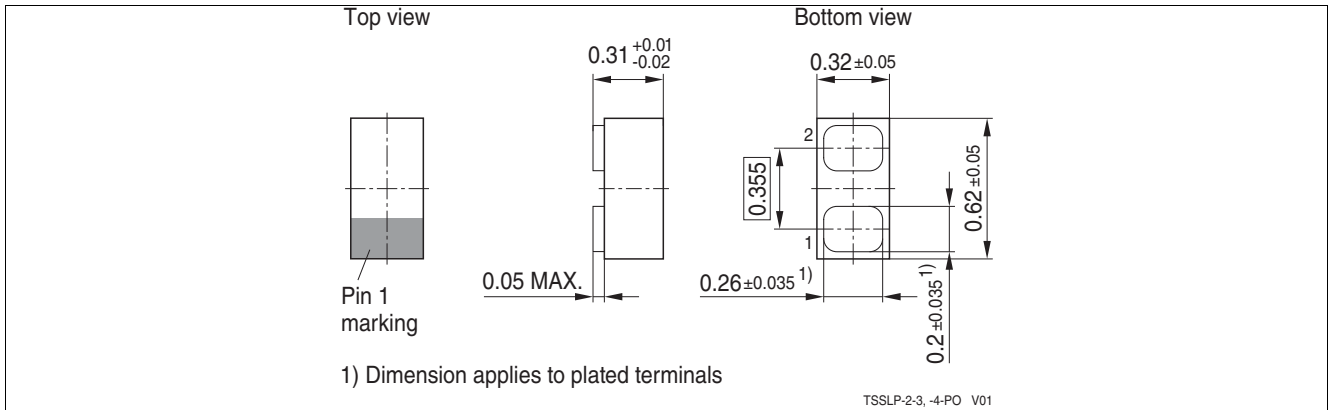

Figure 14 TSSLP-2-3 Package outline (dimension in mm)

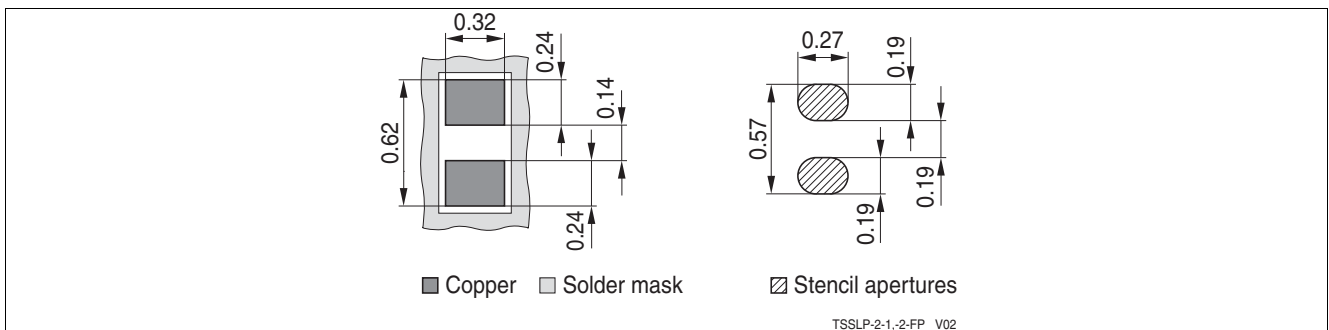

Figure 15 TSSLP-2-3 Footprint (dimension in mm)

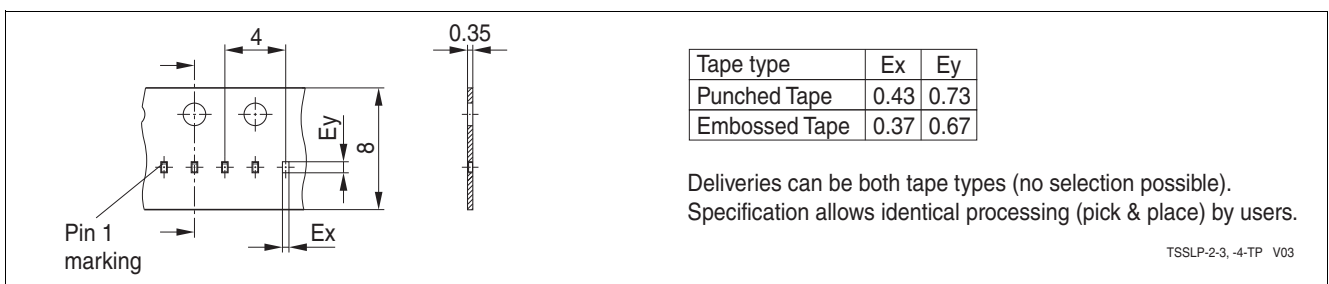

Figure 16 TSSLP-2-3 Packing (dimension in mm)

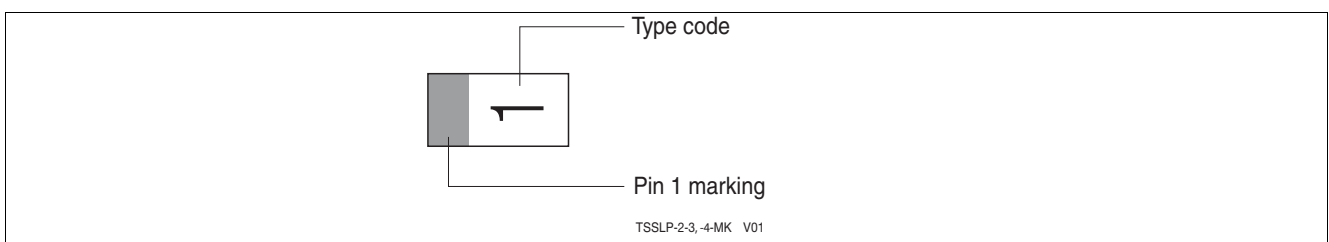

Figure 17 TSSLP-2-3 Marking example [Table 1 "Part Information" on Page 3](#)

**References**

- [1] On-chip ESD protection for integrated circuits, Albert Z. H. Wang, ISBN:0-7923-7647-1
- [2] Infineon AG - **Application Note AN210**: Effective ESD Protection Design at System Level Using VF-TLP Characterization Methodology
- [3] Infineon AG - Recommendations for PCB Assembly of Infineon TSLP and TSSLP Package

**Revision History: Revision 1.1, 2014-02-13**

Page or Item	Subjects (major changes since previous revision)
<b>Revision 1.2, 2015-12-14</b>	
All	Layout change

**Trademarks of Infineon Technologies AG**

AURIX™, BlueMoon™, COMNEON™, C166™, CROSSAVE™, CanPAK™, CIPOST™, CoolMOS™, CoolSET™, CORECONTROL™, DAVE™, EasyPIM™, EconoBRIDGE™, EconoDUAL™, EconoPACK™, EconoPIM™, EiceDRIVER™, EUPEC™, FCOS™, HITFET™, HybridPACK™, ISOFACE™, I<sup>2</sup>RF™, IsoPACK™, MIPAQ™, ModSTACK™, my-d™, NovalithIC™, OmniTune™, OptiMOS™, ORIGA™, PROFET™, PRO-SIL™, PRIMARION™, PrimePACK™, RASIC™, ReverSave™, SatRIC™, SIEGET™, SINDRION™, SMARTi™, SmartLEWIS™, TEMPFET™, thinQ!™, TriCore™, TRENCHSTOP™, X-GOLD™, XMM™, X-PMU™, XPOSSYS™.

**Other Trademarks**

Advance Design System™ (ADS) of Agilent Technologies, AMBA™, ARM™, MULTI-ICE™, PRIMECELL™, REALVIEW™, THUMB™ of ARM Limited, UK. AUTOSAR™ is licensed by AUTOSAR development partnership. Bluetooth™ of Bluetooth SIG Inc. CAT-iq™ of DECT Forum. COLOSSUS™, FirstGPS™ of Trimble Navigation Ltd. EMV™ of EMVCo, LLC (Visa Holdings Inc.). EPCOS™ of Epcos AG. FLEXGO™ of Microsoft Corporation. FlexRay™ is licensed by FlexRay Consortium. HYPERTERMINAL™ of Hilgraeve Incorporated. IEC™ of Commission Electrotechnique Internationale. IrDA™ of Infrared Data Association Corporation. ISO™ of INTERNATIONAL ORGANIZATION FOR STANDARDIZATION. MATLAB™ of MathWorks, Inc. MAXIM™ of Maxim Integrated Products, Inc. MICROTEC™, NUCLEUS™ of Mentor Graphics Corporation. Mifare™ of NXP. MIPI™ of MIPI Alliance, Inc. MIPS™ of MIPS Technologies, Inc., USA. muRata™ of MURATA MANUFACTURING CO., MICROWAVE OFFICE™ (MWO) of Applied Wave Research Inc., OmniVision™ of OmniVision Technologies, Inc. Openwave™ Openwave Systems Inc. RED HAT™ Red Hat, Inc. RFMD™ RF Micro Devices, Inc. SIRIUS™ of Sirius Sattelite Radio Inc. SOLARIS™ of Sun Microsystems, Inc. SPANSION™ of Spansion LLC Ltd. Symbian™ of Symbian Software Limited. TAIYO YUDEN™ of Taiyo Yuden Co. TEAKLITE™ of CEVA, Inc. TEKTRONIX™ of Tektronix Inc. TOKO™ of TOKO KABUSHIKI KAISHA TA. UNIX™ of X/Open Company Limited. VERILOG™, PALLADIUM™ of Cadence Design Systems, Inc. VLYNQ™ of Texas Instruments Incorporated. VXWORKS™, WIND RIVER™ of WIND RIVER SYSTEMS, INC. ZETEX™ of Diodes Zetex Limited.

Last Trademarks Update 2010-06-09

www.infineon.com

Published by Infineon Technologies AG

Downloaded From [Oneyac.com](https://www.oneyac.com)



单击下面可查看定价，库存，交付和生命周期等信息

[>>Infineon Technologies\(英飞凌\)](#)

[>>点击查看相关商品](#)